

# Force that can *hardly be restrained.*

The new DiaForce diagonal compact fans.

**ebmpapst**

engineering a better life

# We love a challenge, even if it's *gigantic*.

Two axial fans that turn in opposite directions and are connected in series may produce a higher air performance than individual solutions, but the higher noise generation brings a different natural barrier. Providing the system with more insulation is generally undesirable, as it requires more space and results in higher costs.

Although current single-stage axial fans are quieter, they deliver less air performance. Even with powerful DC motors and optimized aerodynamics, as offered by the S-Force series from ebm-papst, the performance capability is limited by physical design factors.

Is there a solution that is just as compact, but delivers more power without getting louder? Yes, there is. The engineers at ebm-papst have developed it using all the experience of the global technology leader in compact fan solutions.

## There is a lot of GreenIntelligence in our DiaForce with FanCheck:

- Optional diagnostic tool for calculating the actual remaining service life
- Longer use of products without any loss of reliability
- No unplanned failures or “preventive” replacement
- Significant savings in terms of costs and resources



## GreenIntelligence. Making Engineers Happy.

Why do our customers look so happy? Because when it comes to the Internet of Things and the digital transformation, we provide them with a clear competitive edge with GreenIntelligence for intelligent control and interconnection of fans, drives and systems to make applications more powerful, processes more efficient, businesses more successful and their customers more satisfied.

**Compact cooling solutions** mainly call for low-noise solutions that cut costs and are simple to install. GreenIntelligence provides you with high-efficiency fan solutions featuring intelligent networking capabilities, including numerous control and monitoring functions and easy-to-use digital tools.



**Laszlo** can fully depend on his cooling capacity remaining constant at all times.



# Developing the quick, rigorous, the detail.

A well-known electronics giant commissioned us to develop a fan for their latest generation of IT servers, which will facilitate the transition into the age of artificial intelligence. The requirements for the fan cooling were just as clever: 50% more air performance and 6 decibels less noise than the best competitor product currently on the market.

**Our engineers took one deep breath and then got to work. Less than a year later, the DiaForce was complete.**

The journey was a prime example of international cooperation and close collaboration with the customer. The ebm-papst sites in Mulfingen, St. Georgen and Shanghai worked hand-in-hand: One worked on the impeller geometry, one developed the new 500-watt electronics and the other took care of the overall design. At the same time, they repeatedly took measurements directly on the customer application.

We did it together: The new DiaForce perfectly meets all requirements, and we achieved this development in record-breaking time. In the end, our customer even installed the fan in another product with an earlier production start to get it onto the market faster. Even our experienced developers had never seen that happen before.



# The DiaForce: *obsessed with*

## **So strong that you (almost) have to chain it up.**

The concept is revolutionary: The new DiaForce has a conical cover plate that rotates with it. The outlet opening is larger than the intake opening. The air flows through the fan in both an axial and a radial direction, enabling a high pressure increase. However, it retains an axial design, which is more favorable to install, combining the advantages of both worlds perfectly.

Compared to a conventional single-stage axial compact fan, the result is more than impressive:

**Up to 50% more air performance**

**Up to 6 dB(A) lower sound level**

What does this mean for your application?

### **At last, more performance without compromises.**

With the new DiaForce, you can improve your system performance while still satisfying all standards such as NEBS, OSHA, ANSI and ETSI.

### **More reliability.**

Use the DiaForce's power reserves to create redundancy. If, for example, the outdoor temperature rises due to faulty air conditioning, simply increase the speed. This is hardly possible with conventional single-stage fans because they have to be operated at the power limit even during normal operation.

The DiaForce's outstanding performance also ideally equips you for future IT applications. Consider the growing performance requirements that will be ushered in by the new 5G communication standard, autonomous driving or artificial intelligence.

### **Less effort.**

Wave goodbye now to the time-consuming and costly "handicraft" of having two fans placed on top of each other. The DiaForce is a complete, perfectly coordinated system consisting of a high-performance DC motor, optimized aerodynamics and intelligent control electronics. Easy to install and cool.



# Diagonal compact fan innovation: *Keep cool, big data.*

As with an axial compact fan, the DiaForce also draws in and blows out air in an axial direction. Compared to a centrifugal fan, this design is advantageous when integrating it into the application. But the real revolutionary part happens between the intake and outlet, more specifically in the unique geometry of the impeller and housing:

#### **More pressure thanks to diagonal characteristics.**

The DiaForce's cover plate is cut in a conical shape: the intake opening is smaller than the outlet opening. This creates a larger pressure increase. Therefore, in terms of its characteristics, the DiaForce is between an axial and a centrifugal fan.

#### **Less noise thanks to aerodynamic optimization.**

The blade tips pass directly into the cover plate. As a result, there is no tip gap and therefore hardly any turbulence in the gap area, where there is a significant pressure gradient. This results in a significant reduction in noise.

#### **Option to add integrated FanCheck diagnostic tool.**

Not just power, but brains too: The new FanCheck can be added to the DiaForce on request. The diagnostic tool integrated into the fan electronics calculates the realistic service life of the fan based on temperature, speed and preset environmental parameters. This means it can stay in operation for longer without any loss of reliability. This saves on costs and protects the environment.



**A direct comparison:**

**Single-stage axial fan:**

The flow passes in an even axial direction. This makes the fan relatively quiet. However, air performance is limited even with an optimal design.

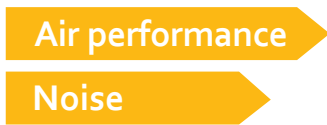

**Two-stage axial fan:**

Two fans placed on top of each other ensure greater air performance, but they are louder, meaning that it is difficult to comply with all legal requirements.

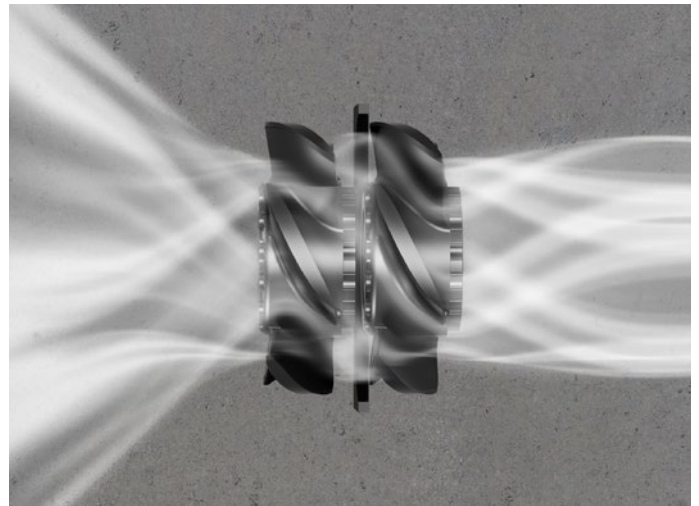

**DiaForce diagonal compact fan:**

The diagonal design enables more pressure to be built up. Aerodynamic optimization also makes it the quietest fan in this power density.

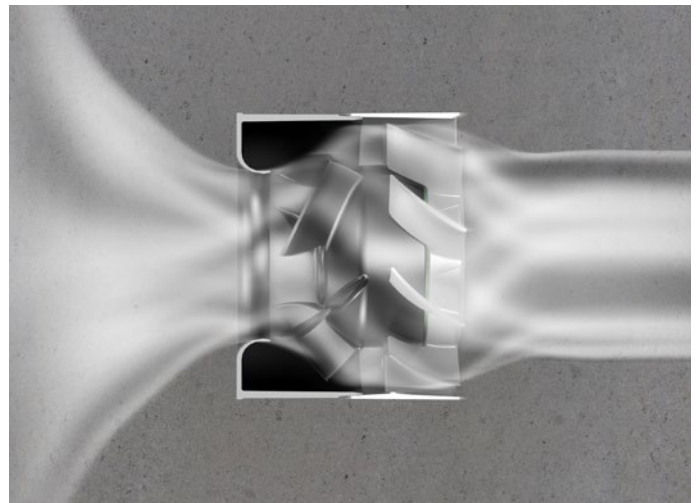

# Superior in all areas.

## Electronics and interfaces

- + **Safe operation**
  - Integrated locked-rotor protection
- + **Functions included**
  - Output signal proportional to speed
  - Speed control with multi-option control input
- + **Available as an option**
  - FanCheck diagnostic tool for calculating the specific remaining service life
  - Go/No Go alarm
  - Alarm with speed limit
  - External temperature sensor
  - Internal temperature sensor
  - Analog control input
  - Moisture protection



## GreenTech DC motor

- + **Unrivalled compactness and strength**
  - Compact motor design
  - Very high motor power of 500 W
- + **Reliable operation**
  - Cooling openings improve the motor's heat management
  - Cooling openings and metal dissipate heat from the ball bearings
  - Long service life, proof through long-term service life tests
- + **Minimal vibration**
  - Dynamic balancing of the impeller
- + **Sustainable design**
  - Magnets without rare earths
  - 3-core GreenTech DC motors







### Flow-optimized housing

- + Powerful**
  - Profiled guide vanes in the air outlet area for additional pressure increase
- + Noise reduction**
  - Aerodynamically optimized inlet nozzle
  - Reduced blade passing noise
  - 6 dB(A) lower noise characteristics in normal operation
- + Simple installation**
  - Easy installation due to 4 holes provided on the inlet and outlet sides
  - Assembly geometry like industry standard
  - Compact design



### Innovative high-performance impeller

- + High pressure increase**
  - Diagonal design, e.g. conical cover plate
- + Low noise emissions**
  - Rotating cover plate, resulting in less turbulence and reduced blade passing noise
- + High efficiency**
  - Overall efficiency of 48%



Subject to technical changes.

# The right stuff, inside and out.

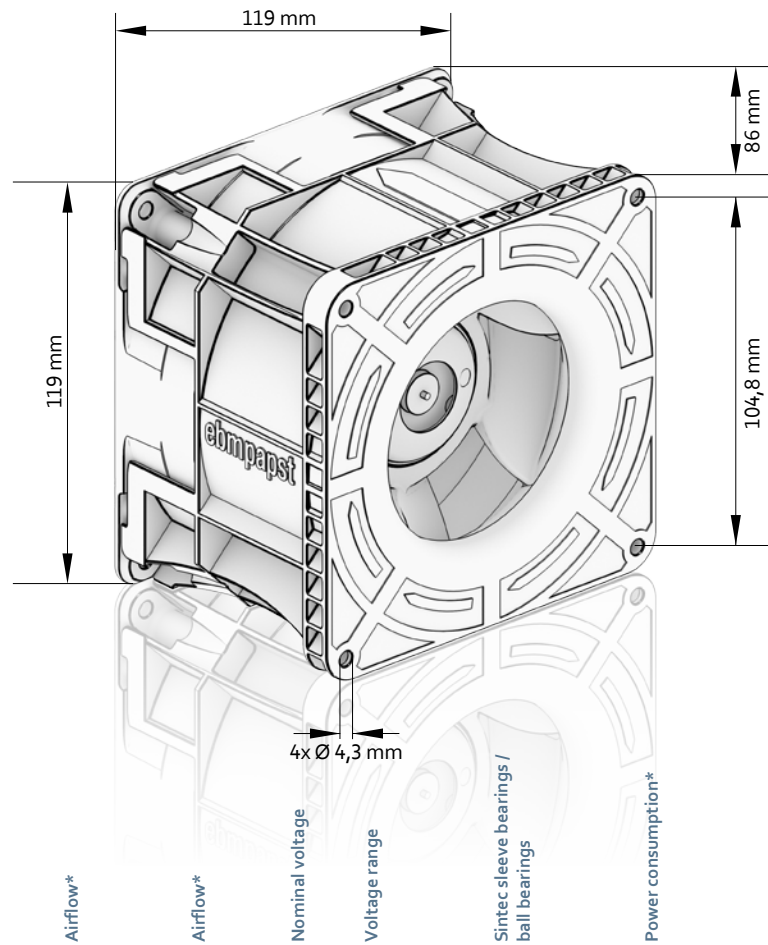

## Nominal data

Type	Standard	Airflow* m³/h	Airflow* cfm	Nominal voltage VDC	Voltage range VDC	Sintec sleeve bearings / ball bearings	Power consumption* W	Nominal speed* rpm	Temperature range °C
VKC0120DULDS	8315100198	680	400	48	36 ... 60	■ / ■	395	17,200	-20 to +70

\*Value for free-air operation  
Data sheets on request. Subject to technical changes.

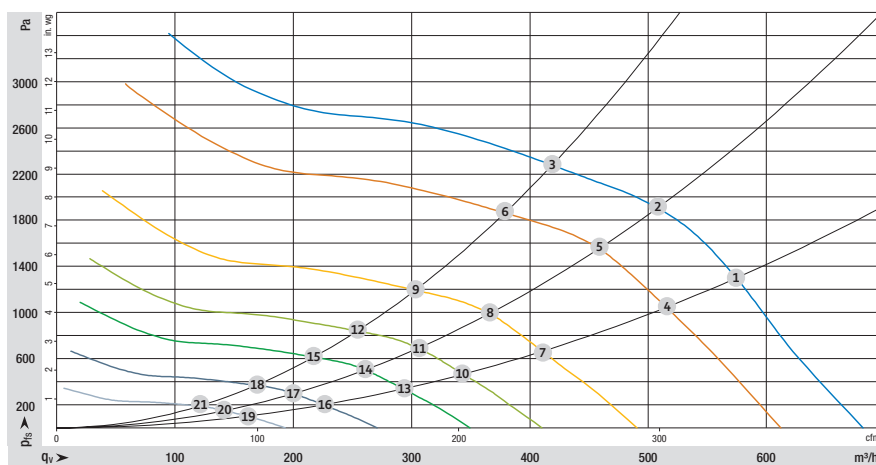

## Want to find out more?

We would be happy to assist you:  
Tel. +1 860-674-1515  
sales@us.ebmpapst.com

OP	1	2	3	4	5	6	7	8	9	10	11	12	13	14	15	16	17	18	19	20	21
n (rpm)	17,200	17,140	17,140	15,500	15,500	15,500	12,480	12,480	12,480	10,490	10,490	10,500	9,000	9,000	9,000	7,000	7,000	7,000	5,000	5,000	5,000
Pe (W)	490	516	516	357	380	384	192	205	206	120	126	128	82	86	88	45	46	47	22	22	23
LwA(dB(A))	92	91	92	90	88	89	85	84	85	81	80	80	77	76	76	72	70	70	63	62	62

# About ebm-papst.

ebm-papst is a leader in ventilation and drive engineering technology and a much sought-after engineering partner in many industries. With around 20,000 different products, we have the perfect solution for practically every requirement. We have placed the highest emphasis on economy and ecology for many years.

We believe the consistent further development of our highly-efficient GreenTech EC technology provides our customers with the best opportunities for the future in industrial digitization. With GreenIntelligence, ebm-papst already offers intelligent networked complete solutions that are unique anywhere in the world today and that secure our customers a decisive advantage.

The logo for ebm-papst, featuring the company name in a bold, blue, sans-serif font.The tagline "engineering a better life" in a white, sans-serif font, set against a blue rectangular background.

## Six reasons that make us the ideal partner:

### **Our systems expertise.**

You want the best solution for every project. The entire ventilation system must thus be considered as a whole. And that's what we do – with **motor technology** that sets standards, sophisticated **electronics** and **aerodynamic** designs – all from a single source and perfectly matched.

### **Our spirit of invention.**

We are also always able to develop customized solutions for you with our versatile team of over 600 engineers and technicians.

### **Our lead in technology.**

We are not only pioneers and trailblazers in the development of highly efficient EC technology, we also recognized the opportunities of digitization at an early stage. Therefore, we can offer solutions today that combine the highest energy efficiency with the advantages of IoT and digital networking.

### **Closeness to our customers.**

ebm-papst has 25 production locations worldwide (including facilities in Germany, China and the USA), together with 48 sales offices, each of which has a dense network of sales representatives. You will always have a local contact, someone who speaks your language and knows your market.

### **Our standard of quality.**

Our quality management is uncompromising, at every step in every process. This is underscored by our certification according to international standards including DIN EN ISO 9001, TS declaration of conformity and DIN EN ISO 14001.

### **Our sustainable approach.**

Assuming responsibility for the environment, for our employees and for society is an integral part of our corporate philosophy. We develop products with an eye to maximum environmental compatibility, in particular resource-preserving production methods. We promote environmental awareness among our young staff and are actively involved in sports, culture and education. That's what makes us a leading company – and an ideal partner for you.

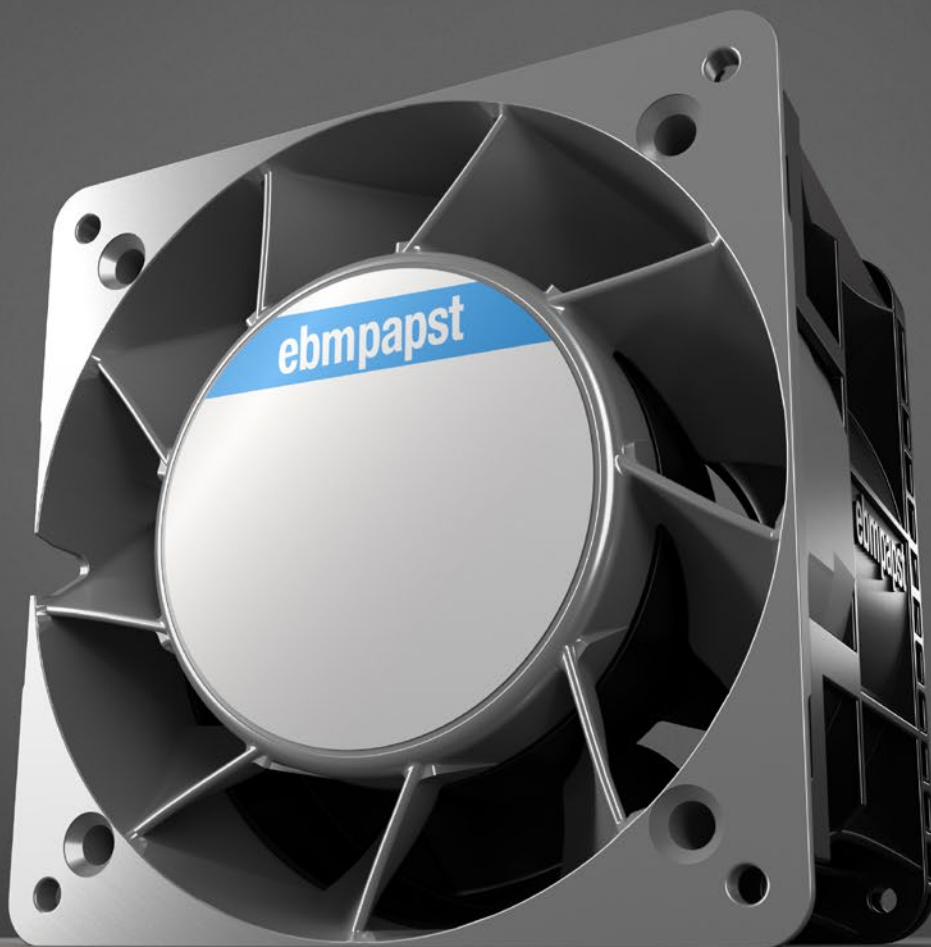

ebm-papst Inc.

100 Hyde Rd.  
Farmington, CT 06034  
USA  
Phone +1 860-674-1515  
sales@us.ebmpapst.com

[www.ebmpapst.com](http://www.ebmpapst.com)